



GOLDBERG BROTHERS

BARN DOOR HARDWARE

2023 EDITION

STANDARD SERIES CATALOG





GOLDBERG BROTHERS

BARN DOOR HARDWARE

STANDARD SERIES CATALOG

TABLE OF CONTENTS

Hardware sets, roller hangers	2	Pull handles, flush pulls, latches	9
Tracks	4	Accent trims	10
Accessories	4	Installation reference guides	12
Bypass hardware	8	Warranty	16
		Color samples	inside back cover

Visit GOLDBERGBROTHERS.COM for additional information and full installation instructions for most products.

Put your barn doors on the right track with the quality and convenience of Goldberg Brothers barn door hardware. Our award-winning products help make efficient use of any indoor living or working space. Our rustic, yet elegant, industrial design provides a bold focal point to any décor.

The Standard Series is our flagship line of barn door hardware products, appropriate for use with doors in most popular sizes. Standard Series hangers are equipped with durable steel rollers, or you can order silent rollers as a factory-installed option. Hardware, hangers, and track are available in raw steel or 16 different colors. All major steel components are made with up to 90% recycled materials.

Goldberg Brothers products have been proudly made in USA since 1897. Our commitment to quality, craftsmanship and value is built into everything we do.

STANDARD SERIES: HARDWARE SETS, ROLLER HANGERS

J Strap Hardware Set

weight limit 400 lb



for 1⅜" thick door	60013H-*
for 1¾" thick door	60014H-*
for 2¼" thick door	60015H-*
universal - for 1⅜" or 1¾" thick door	60015UH-*

Set includes:

- 2 standard J strap hangers with bolts and nuts
- wall mounting hardware set (6 lag bolts, spacers and washers)
- 2 track stops
- 2 anti-jump blocks with screws
- floor guide (T) with screws
- felt pads
- rubber bumper bands

Flattop Strap Hardware Set

weight limit 400 lb



for 1⅜" thick door	60013HFT-*
for 1¾" thick door	60014HFT-*
for 2¼" thick door	60015HFT-*
universal - for 1⅜" or 1¾" thick door	60015UHFT-*

Set includes:

- 2 standard Flattop strap hangers with bolts and nuts
- wall mounting hardware set (6 lag bolts, spacers and washers)
- 2 track stops
- 2 anti-jump blocks with screws
- floor guide (T) with screws
- felt pads
- rubber bumper bands

J Strap Roller Hanger (1 each, with bolts and nuts)

2"×11½"×1½"



for 1⅜" thick door	60013R-*
for 1¾" thick door	60014R-*
for 2¼" thick door	60015R-*

Flattop Strap Roller Hanger (1 each, with bolts and nuts)

2"×11½"×1½"



for 1⅜" thick door	60013RFT-*
for 1¾" thick door	60014RFT-*
for 2¼" thick door	60015RFT-*

J Top Mount Hardware Set

weight limit 100 lb

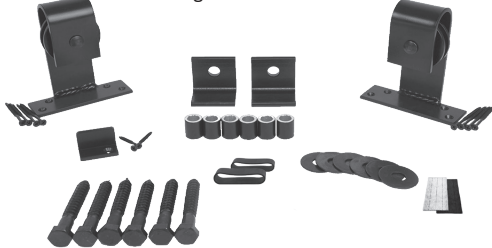

for most common door sizes	60010H -*
----------------------------	-----------

Set includes:

- 2 J top mount hangers with screws
- 2 track stops
- floor guide (T) with screws
- wall mounting hardware set (6 lag bolts, spacers and washers)
- felt pads
- rubber bumper bands

Flattop Top Mount Hardware Set

weight limit 100 lb

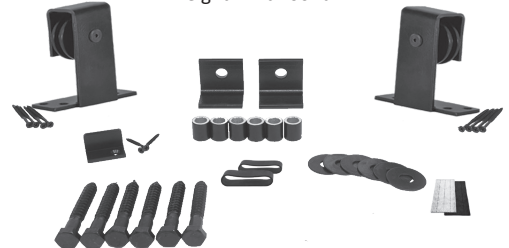

for most common door sizes	60010HFT -*
----------------------------	-------------

Set includes:

- 2 Flattop top mount hangers with screws
- 2 track stops
- floor guide (T) with screws
- wall mounting hardware set (6 lag bolts, spacers and washers)
- felt pads
- rubber bumper bands

Replace the * in the product's SKU with the code for the desired color. See color codes on inside back cover.

STANDARD SERIES: HARDWARE SETS, ROLLER HANGERS

J Top Mount Roller Hanger (1 each, with screws)

4½"×5⅛"×1⅜"



for most common door sizes

60010R-*

Flattop Top Mount Roller Hanger (1 each, with screws)

4½"×5⅛"×1⅜"



for most common door sizes

60010RFT-*

Horseshoe Hardware Set

weight limit 600 lb



for 1⅜" thick door

60013H2-*

for 1¾" thick door

60014H2-*

for 2¼" thick door

60015H2-*

Set includes:

- 2 standard horseshoe hangers with bolts and nuts
- wall mounting set (6 lag bolts, spacers and washers)
- 2 track stops
- 2 anti-jump blocks with screws
- floor guide (T) with screws
- felt pads
- rubber bumper bands

Wagon Wheel Hardware Set

weight limit 400 lb

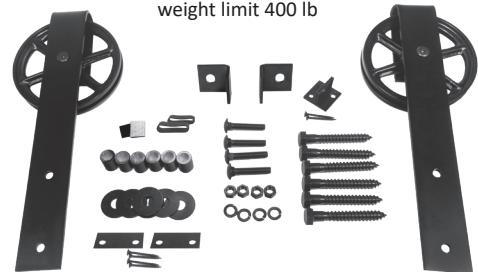

for 1⅜" thick door

60013HW-*

for 1¾" thick door

60014HW-*

for 2¼" thick door

60015HW-*

universal - for 1⅜" or 1¾" thick door

6001UHW-*

Set includes:

- 2 wagon wheel hangers with bolts and nuts
- wall mounting hardware set (6 lag bolts, spacers and washers)
- 2 track stops
- 2 shims with screws
- floor guide (T) with screws
- felt pads
- rubber bumper bands

Horseshoe Roller Hanger (1 each, with bolts and nuts)

8"×10¾"×1½"



for 1⅜" thick door

60013R2-*

for 1¾" thick door

60014R2-*

for 2¼" thick door

60015R2-*

Wagon Wheel Roller Hanger (1 each, with bolts and nuts)

6"×15"×1⅝"



for 1⅜" thick door

60013RW-*

for 1¾" thick door

60014RW-*

for 2¼" thick door

60015RW-*

Replace the * in the product's SKU with the code for the desired color. See color codes on inside back cover.

STANDARD SERIES: HARDWARE SETS, ROLLER HANGERS, TRACKS, ACCESSORIES

Horseshoe Wagon Wheel Hardware Set

weight limit 400 lb

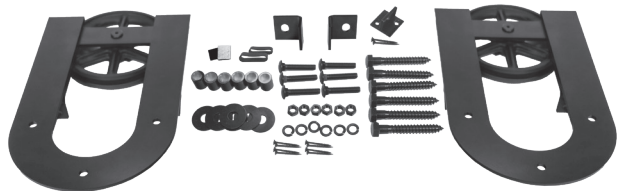

for 1 $\frac{3}{8}$ " thick door	60013H2W-*
for 1 $\frac{1}{4}$ " thick door	60014H2W-*
for 2 $\frac{1}{4}$ " thick door	60015H2W-*
universal - for 1 $\frac{3}{8}$ " or 1 $\frac{1}{4}$ " thick door	6001UH2W-*

Set includes:

- 2 wagon wheel horseshoe hangers with bolts and nuts
- wall mounting set (6 lag bolts, spacers and washers)
- 2 track stops
- floor guide (T) with screws
- 8 wood screws
- felt pads
- rubber bumper bands

Horseshoe Wagon Wheel Roller Hanger (1 each, with bolts and nuts)

8" x 13 $\frac{5}{8}$ " x 1 $\frac{1}{8}$ "



for 1 $\frac{3}{8}$ " thick door	60013R2W-*
for 1 $\frac{1}{4}$ " thick door	60014R2W-*
for 2 $\frac{1}{4}$ " thick door	60015R2W-*

Delrin® Silent Rollers (1 pair, acetal resin, black)

$\frac{5}{8}$ " x 2 $\frac{1}{2}$ " each



6001SR6

Available as a factory-installed substitution for steel rollers. Recommended for doors weighing 200 lb or less.

Flat Track (bar only)

2" x $\frac{3}{16}$ "



4' (for 2'0" wide door)		6001T4-*
5' (for 2'6" wide door)		6001T5-*
5'4" (for 2'8" wide door)		6001T54-*
6' (for 3'0" wide door)		6001T6-*
7' (for 3'6" wide door)		6001T7-*
8' (for 4'0" wide door)		6001T8-*
Biparting 6' (for pair of 1'6" wide doors)		6001T6P-*
Biparting 8' (for pair of 2'0" wide doors)		6001T8P-*
Long lengths	8'1" to 10'	6001T100-*
	10'1" to 16'	6001T160-*
Custom cut service (Order a standard track length longer than what you need. We will cut it down to the correct size for you.)	1 to 5 pieces	6001CCT1
	6 to 11 pieces	6001CCT2
	12 or more pieces	6001CCT4

Soft Stop (set of 2 with black mounting plates, triggers, and screws)



11" between center points of lag bolts (for tracks up to 7')	6001SOFT11
17" between center points of lag bolts (for tracks 8'+)	6001SOFT17
Custom length	6001SOFTCL

Soft Stop motion buffering devices slow down the door and hold it in place when opening or closing. Sold in pairs for mounting on both ends of a track.

Track Lag Cover Caps (set of 6 with screws and installation tool)

1" dia. each



6001LCC-*

Replace the * in the product's SKU with the code for the desired color. See color codes on inside back cover.

STANDARD SERIES: ACCESSORIES

Wall Mounting Hardware (set of 6 bolts, washers, spacers)



for 1 $\frac{3}{8}$ " thick door	3 $\frac{1}{2}$ " bolts	60013M-*
for 1 $\frac{3}{4}$ " thick door	4" bolts	60014M-*
for 2 $\frac{1}{4}$ " thick door	4 $\frac{1}{4}$ " bolts	60015M-*

Track Extension Kit $\frac{1}{2}$ " (set of 6 bolts and spacers)



for 1 $\frac{3}{8}$ " thick door	4" bolts	60013E-*
for 1 $\frac{3}{4}$ " thick door	4 $\frac{1}{2}$ " bolts	60014E-*
for 2 $\frac{1}{4}$ " thick door	5" bolts	60015E-*

Track Extension Kit $\frac{3}{8}$ " (set of 6 bolts and spacers)



for 1 $\frac{3}{8}$ " thick door	4 $\frac{1}{2}$ " bolts	60013EX-*
for 1 $\frac{3}{4}$ " thick door	5" bolts	60014EX-*
for 2 $\frac{1}{4}$ " thick door	6" bolts	60015EX-*

Track Extension Kit 1 $\frac{1}{4}$ " (set of 6 bolts and spacers)



for 1 $\frac{3}{8}$ " thick door	5" bolts	60013EXX-*
for 1 $\frac{3}{4}$ " thick door	6" bolts	60014EXX-*
for 2 $\frac{1}{4}$ " thick door	7" bolts	60015EXX-*

Track Stop (1 each)

2"×2"×1 $\frac{1}{2}$ "



for use with standard J strap and J horseshoe roller hangers 6001S-*

Wagon Wheel Track Stop (1 each)

2"×1 $\frac{1}{8}$ "×1 $\frac{1}{2}$ "



for use with wagon wheel roller hangers 6001S6-*

Adjustable Track Stop (1 each, with set screws and tool)

1"×2 $\frac{5}{16}$ "×2"



6001SC-*

Sidewall Bracket (1 each, with screws and nuts)



standard	1 $\frac{1}{2}$ "×2"×2"	6001SW-*
long	1 $\frac{1}{2}$ "×2"×2 $\frac{1}{2}$ "	6001SWE-*
extra long	1 $\frac{1}{2}$ "×2"×3 $\frac{1}{4}$ "	6001SWEX-*

Replace the * in the product's SKU with the code for the desired color. See color codes on inside back cover.

STANDARD SERIES: ACCESSORIES

Floor Guide (T) (aluminum, 1 each, with screws)



1½"×1½"×1"

6001G-*

Continuous Floor Guide (1 each, aluminum)

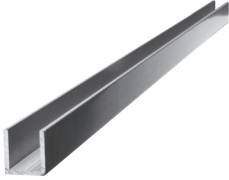

1¼"×¾"×95"

6001FGC

Adjustable U-Guide (2 pieces, with screws)



7⁄8"×1"×1½" each

6001U-*

Track Connecting Plate (1 each)

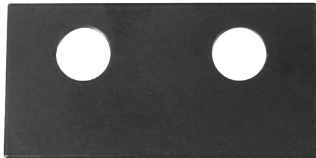

3"×1½"

6001C-*

Connects two shorter tracks to function as one longer track. Not required for biparting doors.

Track Support Z-Brackets (set of 2, with lag bolts)



1¼"×4½"×2" each

6001TZ-*

Floor T Guide 24" (aluminum, 1 each, with screws)



1½"×24"×1"

6001G2-*

Continuous Floor Guide Pins (set of 2, with screws)

2"×¾"×½" each



6001FGP

All-in-One Floor Guide (1 each, with screws)



6001GA-*

Corner-Converging Bracket (1 each, with bolt and nuts)



6001OC-*

Hollow-Core Plates (set of 2)



2"×6⅞" each

6001HCP-*

Replace the * in the product's SKU with the code for the desired color. See color codes on inside back cover.

STANDARD SERIES: ACCESSORIES

Pair Linking Kit

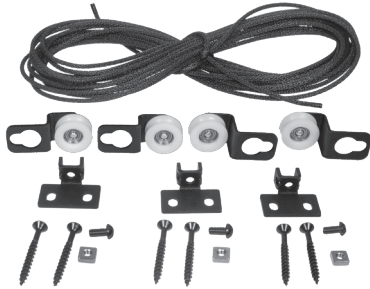

for biparting doors 36" or less	24' cord	6002PLK24-MB
for biparting doors up to 72"	50' cord	6002PLK50-MB

Replacement Cord for Pair Linking Kit



24' cord	black	6002PLC24
50' cord	black	6002PLC40

Anti-Jump Blocks (clear acrylic, set of 2 with screws and felt pads)

1"×2"×¼" each



6001J

Hanger Bolts Installation Template (1 each)

6½"×6½"×¼"



6001TMP-1

Felt Pads (set of 4, felt strips with adhesive back)

1"×¾" each strip

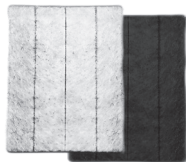

White	6001BS-1
Black	6001BS-6

Rubber Bumper Band (1 each)

2"×¾"



Black	6001834
-------	---------

Hanger Stabilizer (Set of 2, with screws)

2¼"×1⅛" each



6001HS-*

Touch-Up Paint (1 bottle, with brush)

0.6 fl oz each



6001P-*

Replace the * in the product's SKU with the code for the desired color. See color codes on inside back cover.

STANDARD SERIES: BYPASS HARDWARE

Bypass J Strap Hardware Set



for 1 $\frac{3}{8}$ " thick door	60013HX-*
for 1 $\frac{3}{4}$ " thick door	60014HX-*
for 2 $\frac{1}{4}$ " thick door	60015HX-*

Set includes:

- 2 Bypass door hangers
- Bypass J-guide
- 3 grab/push stops
- 2 steel anti-jump blocks
- 2 track stops
- Standard track mounting hardware
- Felt pads

Bypass Flattop Strap Hardware Set



for 1 $\frac{3}{8}$ " thick door	60013HXFT-*
for 1 $\frac{3}{4}$ " thick door	60014HXFT-*
for 2 $\frac{1}{4}$ " thick door	60015HXFT-*

Set includes:

- 2 Bypass door hangers
- Bypass J-guide
- 3 grab/push stops
- 2 steel anti-jump blocks
- 2 track stops
- Standard track mounting hardware
- Felt pads

Bypass J Strap Roller Hanger (1 each, with bolts and nuts)

2"×17 $\frac{1}{8}$ "×1 $\frac{1}{2}$ "



for 1 $\frac{3}{8}$ " thick door	60013RX-*
for 1 $\frac{3}{4}$ " thick door	60014RX-*
for 2 $\frac{1}{4}$ " thick door	60015RX-*

Bypass Flattop Strap Roller Hanger (1 each, with bolts and nuts)

2"×17 $\frac{1}{8}$ "×1 $\frac{1}{2}$ "



for 1 $\frac{3}{8}$ " thick door	60013RXFT-*
for 1 $\frac{3}{4}$ " thick door	60014RXFT-*
for 2 $\frac{1}{4}$ " thick door	60015RXFT-*

Bypass Spacer Kit (no soffit)



for 1 $\frac{3}{8}$ " thick door	60013MX-*
for 1 $\frac{3}{4}$ " thick door	60014MX-*
for 2 $\frac{1}{4}$ " thick door	60015MX-*

Bypass J-Guide (1 each, with screws)



for 1 $\frac{3}{8}$ " thick door	1 $\frac{1}{2}$ "×1 $\frac{3}{4}$ "×1 $\frac{11}{16}$ "	60013GX-*
for 1 $\frac{3}{4}$ " thick door	1 $\frac{1}{2}$ "×1 $\frac{3}{4}$ "×1 $\frac{1}{8}$ "	60014GX-*
for 2 $\frac{1}{4}$ " thick door	1 $\frac{1}{2}$ "×1 $\frac{3}{4}$ "×2 $\frac{1}{8}$ "	60015GX-*

Bypass Anti-jump blocks (set of 2, with nuts)



1 $\frac{1}{2}$ "× $\frac{3}{4}$ "× $\frac{3}{4}$ " each

6001JX-*

Bypass Grab/Push Stops (set of 3, with screws)

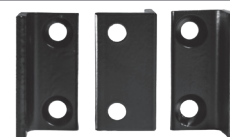

1 $\frac{1}{2}$ "× $\frac{3}{4}$ "× $\frac{3}{4}$ " each

6001PSX-*

Bypass Soft Stop Trigger Kit (set of 2)



5"×1 $\frac{1}{4}$ "×1 $\frac{1}{4}$ " each

6001SOFTXTR-*

Replaces the anti-jump block attached to each bypass J strap Roller Hanger.

Replace the * in the product's SKU with the code for the desired color. See color codes on inside back cover.

STANDARD SERIES: HANDLES, PULLS, LATCHES

7" Pull Handle (1 each, with bolts, washers and nuts)

1½"×7" CL bolts ×1¼"



fits 1⅜" thick door	6001PH307-*
fits 1¾" thick door	6001PH407-*
fits 2¼" thick door	6001PH507-*
Universal (fits all 3)	6001PH007-*

11" Pull Handle (1 each, with bolts, washers and nuts)

1½"×11" CL bolts ×1¼"



fits 1⅜" thick door	6001PH311-*
fits 1¾" thick door	6001PH411-*
fits 2¼" thick door	6001PH511-*
Universal (fits all 3)	6001PH011-*

16" Pull Handle (1 each, with bolts, washers and nuts)

1½"×16" CL bolts ×1¼"

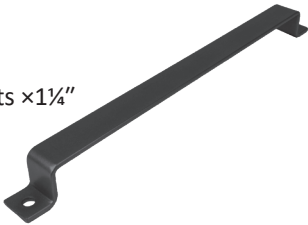

fits 1⅜" thick door	6001PH316-*
fits 1¾" thick door	6001PH416-*
fits 2¼" thick door	6001PH516-*
Universal (fits all 3)	6001PH016-*

24" Pull Handle (1 each, with bolts, washers and nuts)

1½"×24" CL bolts ×1¼"

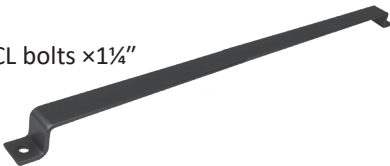

fits 1⅜" thick door	6001PH324-*
fits 1¾" thick door	6001PH424-*
fits 2¼" thick door	6001PH524-*
Universal (fits all 3)	6001PH024-*

6" Flush Pull (1 each, with face plate, dustbox and screws)

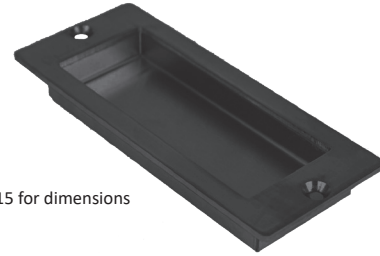

See page 15 for dimensions

6001FP06-*

12" Flush Pull (1 each, with face plate, dustbox and screws)

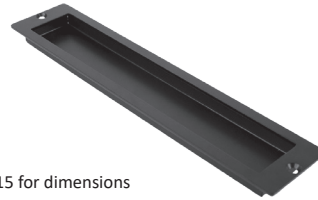

See page 15 for dimensions

6001FP12-*

Privacy Latch (1 each, with faceplate, dustbox, strike plate and screws)



See page 14 for dimensions

6001PL-*

Biparting Privacy Latch (1 set, with screws)



See page 15 for dimensions

6001PLP-*

Router Templates (set of 3, clear plastic)



flush pulls and privacy latch templates

6001TMP-2















Replace the * in the product's SKU with the code for the desired color. See color codes on inside back cover.

STANDARD SERIES: ACCENT TRIMS

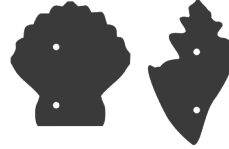

Customize your Goldberg Brothers Standard Series J strap roller hangers with a pair of decorative accent trims. These fun accessories add your personal style to our barn door hardware. With dozens of designs available, you can even swap them out for different holidays and seasons. They are sold in either themed sets or identical pairs and are available in raw steel and all sixteen of our standard powder coat colors.

To install, simply remove the nuts and washers from the front of your installed roller hangers, slip the accent trims over the bolts, replace the washers and refasten the nuts.

<p>Cowboys Set</p>  <p>5 5/8" x 8 1/2" 5 1/4" x 8 1/2" 6001AT102</p>	<p>Horseshoe (pair)</p>  <p>5 3/8" x 8 1/2" 6001AT101</p>	<p>Lone Star (pair)</p>  <p>5 5/8" dia. 6001AT002</p>	<p>Arrowhead (pair)</p>  <p>5 5/8" x 8 3/4" 6001AT003</p>	<p>Horse Head (pair)</p>  <p>6 3/8" x 7 3/4" 6001AT241</p>
<p>Coyote (pair)</p>  <p>4 7/8" x 9 3/4" 6001AT235</p>	<p>Deer (pair)</p>  <p>6" x 9 3/8" 6001AT231</p>	<p>Bear (pair)</p>  <p>6" x 11 3/8" 6001AT245</p>	<p>Eagle Head (pair)</p>  <p>6 3/4" x 8 3/4" 6001AT203</p>	<p>Bird (pair)</p>  <p>5 5/8" x 8 5/8" 6001AT201</p>
<p>Birds on Limb (pair)</p>  <p>6" x 10 3/8" 6001AT202</p>	<p>Dolphin (pair)</p>  <p>8 1/4" x 12 1/4" 6001AT281</p>	<p>Seashell Set</p>  <p>7 1/4" x 7 1/2" 5 1/4" x 8 7/8" 6001AT611</p>	<p>Lighthouse (pair)</p>  <p>4 7/8" x 8 3/4" 6001AT601</p>	<p>Palm Tree (pair)</p>  <p>5 1/2" x 10" 6001AT303</p>

STANDARD SERIES: ACCENT TRIMS

Pineapple (pair)



4¾"×8¼" 6001AT341

Tree (pair)



5¾"×8" 6001AT301

Pine Tree (pair)



6"×10¼" 6001AT302

Maple Leaf (pair)



6½"×7½" 6001AT331

Rose (pair)



5¾"×8½" 6001AT321

Cupid Set

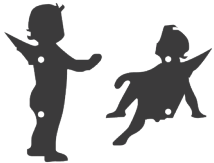

6¼"×10½"
7"×8" 6001AT801

Sword (pair)



4¼"×14¼" 6001AT001

Football Set

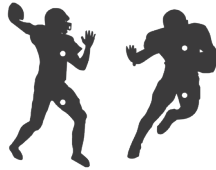

6¾"×11½"
6½"×11" 6001AT511

Basketball Set



7½"×12¼"
7½"×16¾" 6001AT521

Baseball Set

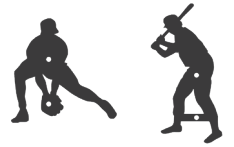

8¾"×8¾"
5¾"×11½" 6001AT501

Hockey Set



6¼"×11¾"
8"×10½" 6001AT541

Skier Set

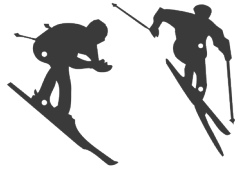

8"×10½"
10"×12¾" 6001AT561

Golf Set

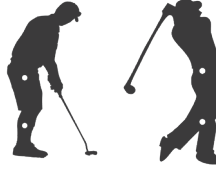

6½"×11½"
6¾"×11¾" 6001AT531

Soccer Set



7½"×10½"
8"×10½" 6001AT551

Surfer Set



9"×10½"
7½"×9½" 6001AT571

Pantry Set



4½"×9¼"
7¾"×8¾" 6001AT151

Grapevine (pair)



6½"×10" 6001AT142

Wine Bottle Set



2¼"×9½"
3¼"×8¾" 6001AT141

GB Reel Set

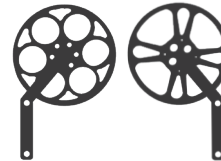

6¾"×10½"
7"×10½" 6001AT121

Theater Set

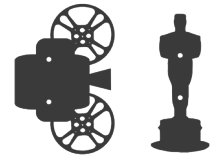

7¾"×12¾"
4½"×11½" 6001AT122

Music Set



4"×9"
3¾"×7¾" 6001AT131



Do you have another design in mind?

We can turn your company logo or original artwork into a set of our accent trims. Contact us for details.



Single-Door & Biparting Pair System Layouts

These basic layouts are compatible with Goldberg Brothers Standard Series, MP/CP Series, Stainless Steel Series, and Hidden Roller Series barn door hardware. Similar layouts are also possible with Shutter Series hardware. This document provides general information. For more specific details and recommendations, see the sizing tables on the "Installation" page at GoldbergBarnTrack.com.

 T-guide location (floor mount)
 Connecting plate (track mount)
 Note: the use and position of connecting plates may vary, depending on track lengths

single door



1 barn door hardware set, 1 track = $2 \times$ the door width $-\frac{1}{2}$ "

single door wider than 4'

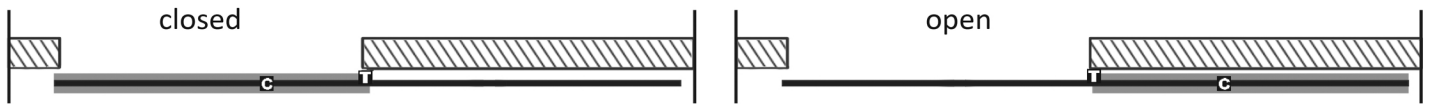

1 barn door hardware set, 1 to 3 tracks = $2 \times$ the door width $-\frac{1}{2}$ " or -1 ", track connecting plate(s), extra wall mount kit(s)

pair of biparting doors

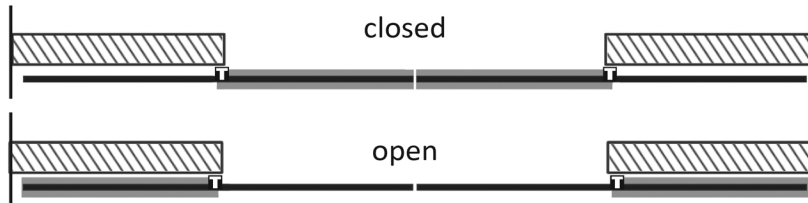

2 barn door hardware sets, 2 tracks each = $2 \times$ one door width (no connecting plate needed)

pair of biparting doors wider than 4' each

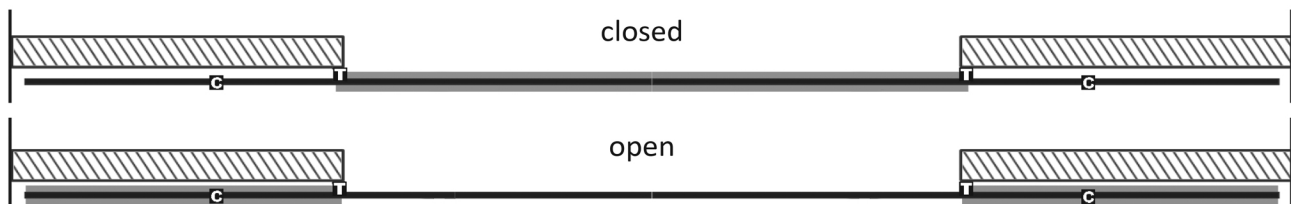



2 barn door hardware sets, 2 or 3 tracks with each pair or trio = $2 \times$ one door width $-\frac{1}{2}$ ", track connecting plate(s), extra wall mount kit(s)

Bypass System Layouts

These basic layouts are compatible with Goldberg Brothers Standard Series, MP/CP Series, and Stainless Steel Series barn door hardware. Similar layouts are also possible with Shutter Series hardware. This document provides general information. For more specific details and recommendations, see the sizing tables on the "Installation" page at GoldbergBarnTrack.com.

2-door system, clear opening

 T-guide location (floor mount)
 J-Guide location (on back door)



1 barn door hardware set, 1 track = $2 \times$ one door width - $\frac{1}{2}$ ", 1 bypass hardware set, 1 or 2 tracks = $3 \times$ one door width - 1". Add connecting plate and wall mounting kit for third track if needed. Add bypass spacer kit(s) if needed.

4-door system, clear opening

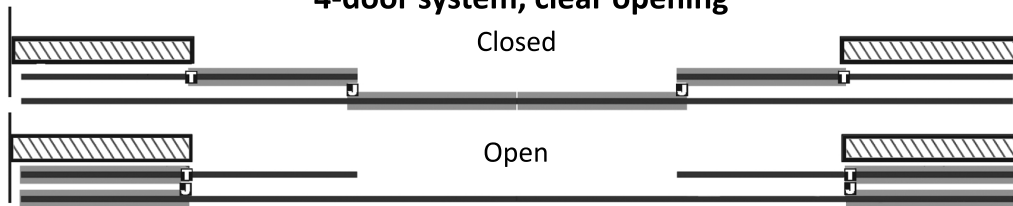

2 barn door hardware sets, 2 tracks each = $2 \times$ one door width - $\frac{1}{2}$ ", 2 bypass hardware sets, 2 or 3 tracks total = $6 \times$ one door width - 2". Add connecting plates, wall mounting kits, and bypass spacer kit(s) if needed.

2-door system, pass-through opening



1 barn door hardware set, 1 bypass hardware set, 2 tracks each = $2 \times$ one door width - 1". Add 1 extra T-guide and bypass spacer kit if needed.

4-door system, pass-through opening

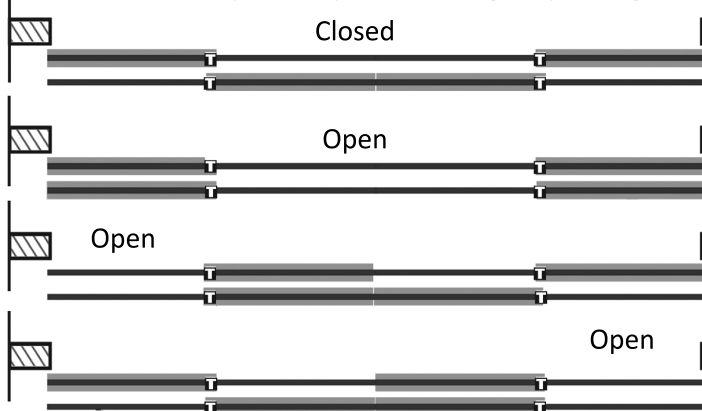

2 hardware sets, 2 bypass hardware sets, 4 tracks each = $2 \times$ one door width - 1". Add extra T-guides and bypass spacer kits if needed.

3-door system, pass-through opening

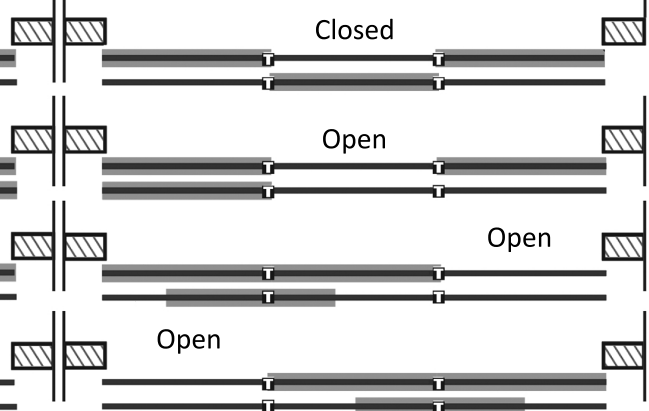

2 barn door hardware sets, 1 bypass hardware set, 2 extra T-guides, 2 tracks each = $3 \times$ one door width - 2", 2 connecting plates, 1 wall mount kit. Add 1 extra bypass spacer kit if needed.

Pull Handles

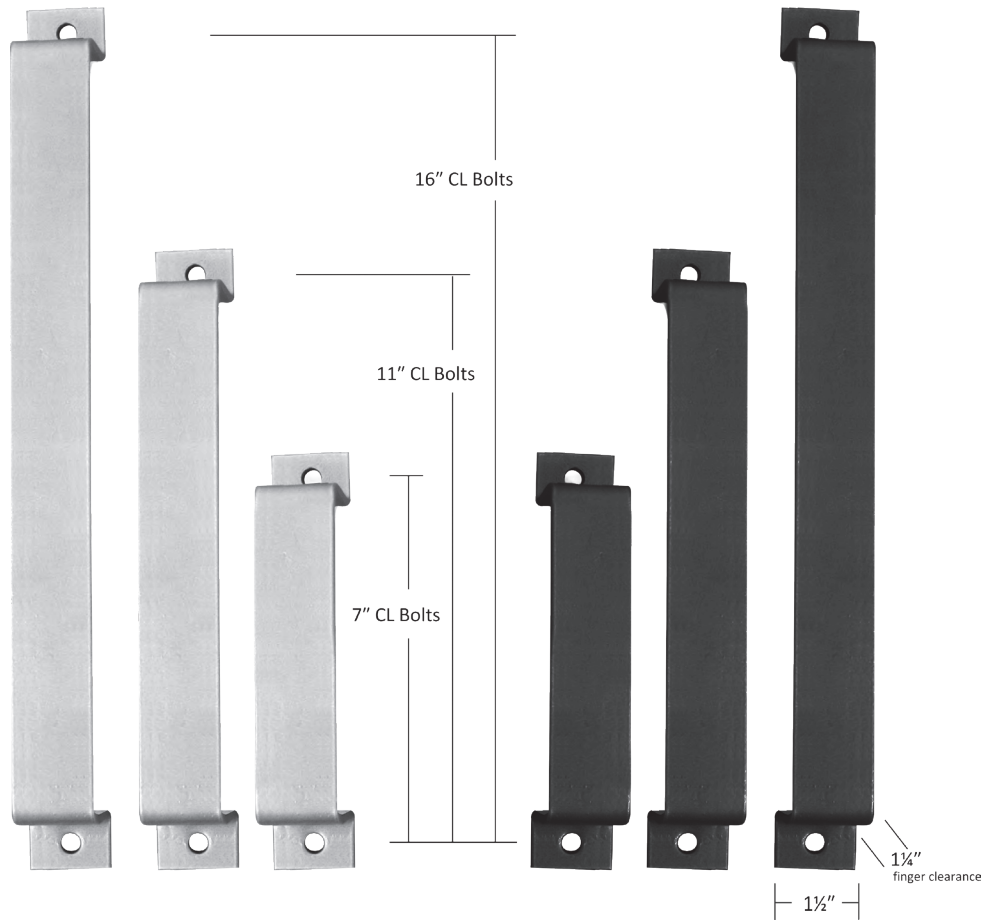

7" Pull Handle	1" 6001PH307-*	1 ³ / ₄ " 6001PH407-*	2 ¹ / ₄ " 6001PH507-*	Universal 6001PH007-*
11" Pull Handle	1" 6001PH311-*	1 ³ / ₄ " 6001PH411-*	2 ¹ / ₄ " 6001PH511-*	Universal 6001PH011-*
16" Pull Handle	1" 6001PH316-*	1 ³ / ₄ " 6001PH416-*	2 ¹ / ₄ " 6001PH516-*	Universal 6001PH016-*
24" Pull Handle	1" 6001PH324-*	1 ³ / ₄ " 6001PH424-*	2 ¹ / ₄ " 6001PH524-*	Universal 6001PH024-*

Privacy Latch

6001PL-*

³/₁₆" x 1¹/₄" solid bar stock

includes jamb strike & screws

When door is on the outside of the room then the latch mounts to the door. When door is on the inside of the room then the latch mounts to the wall.

dustbox mortise PL = 2¹/₈" x ⁷/₈" x ¹/₂"

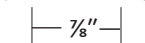
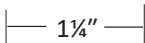
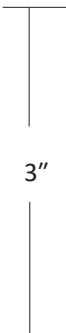
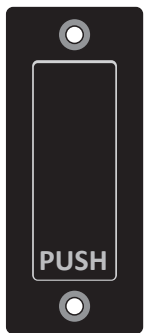

recessed box

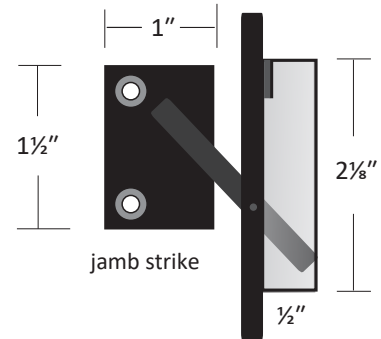

Flush Pulls

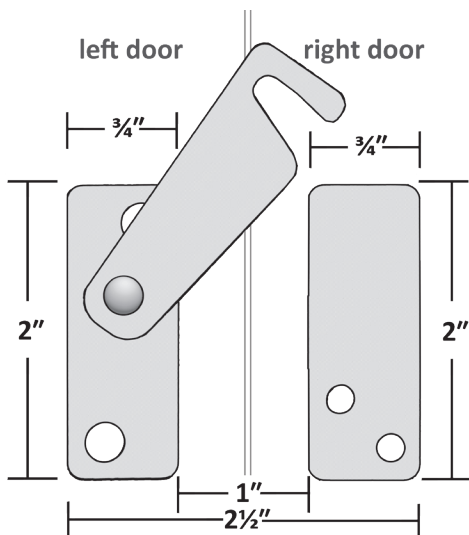
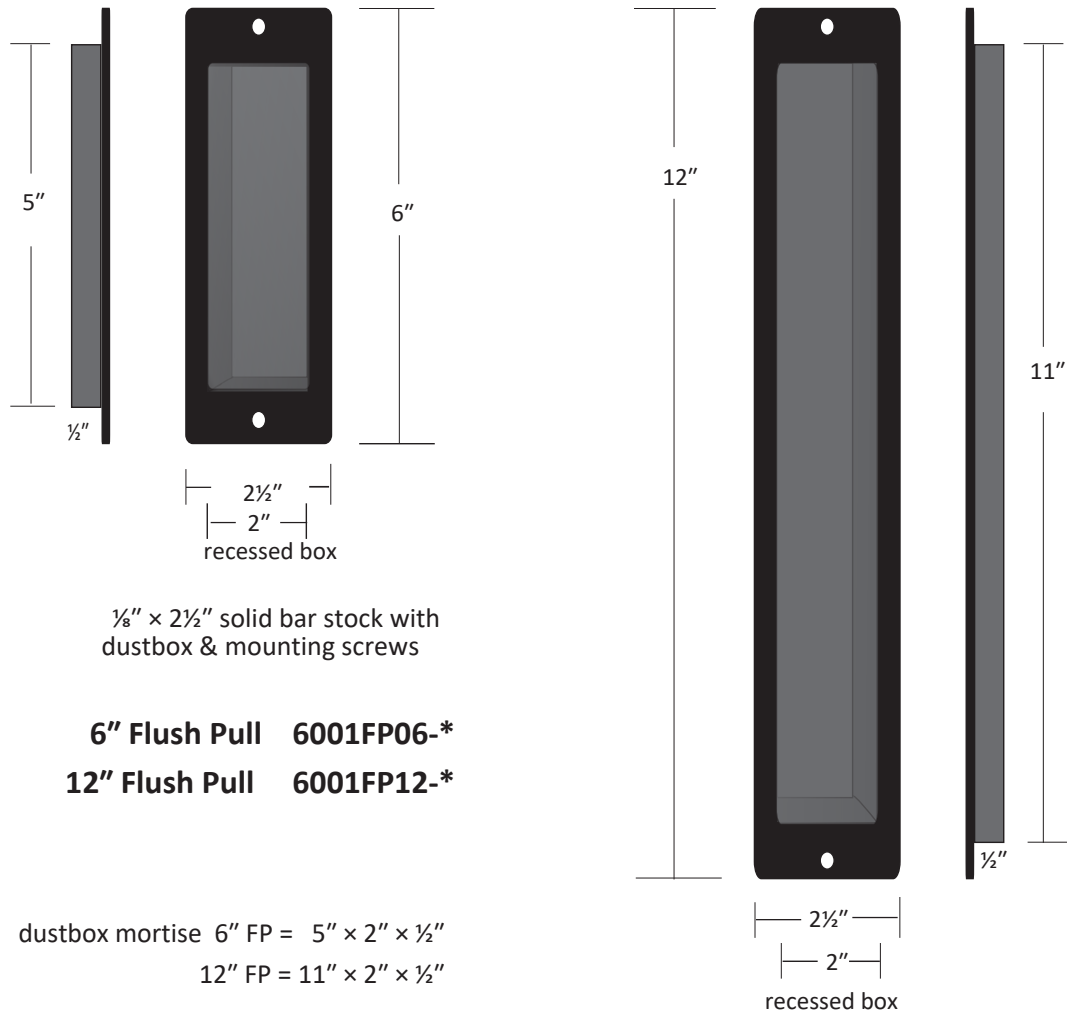

Privacy Latch for biparting doors

6001PLP-*
includes four mounting screws

Close doors and mount components with screwdriver while latch is in closed position.

WARRANTY

LIMITED LIFETIME MANUFACTURER'S WARRANTY

Goldberg Brothers warrants the functionality of its barn door hardware sets and tracks with a limited lifetime manufacturer's warranty for defective parts under normal installation and use. Warranty is subject to repair or replacement of defective components at manufacturer's discretion and does not include installation costs.

This warranty does not apply to the cosmetic condition of any products or components. Goldberg Brothers does not warrant against the loss of finish at points where the rollers are in contact with the track. Goldberg Brothers barn door hardware is sold as a rustic finished hardware and may develop scratches or other signs of wear during manufacturing or normal installation and use. Further, Goldberg Brothers does not warrant against any cosmetic imperfections in the steel parts that may be seen through the finish.

Certain accessories including but not limited to felt strips, rubber bumper bands, pair linking cords, and Soft Stop motion buffer mechanisms have finite expected lifetimes due to wear and loss of tension or resilience during normal use over an extended period. Except for manufacturing defects that become apparent within 1 year of purchase, these accessories are not covered under this limited lifetime warranty. Replacement accessories may be purchased as needed from Goldberg Brothers retailers.

Except for stainless steel components, Goldberg Brothers barn door hardware products are not warranted against rust. Some rusting is possible on any raw steel or powder coated steel hardware installed outdoors or anywhere else that it may be exposed to high humidity, rain, snow, or running water.

This warranty does not include loss or defects caused by elements outside the control of Goldberg Brothers, Inc., such as natural disasters, weather, fire, water leakage, abuse, improper installation, or anything else deemed out of the control of Goldberg Brothers, Inc.











GOLDBERG BROTHERS
BARN DOOR HARDWARE







STANDARD SERIES HARDWARE COLORS

Products with SKUs that end with a dash and asterisk -* are available in multiple colors.

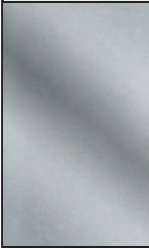
Replace the asterisk * with the desired color code.

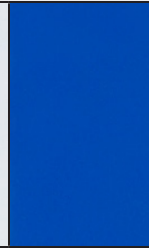
ECONOMY COLORS			STANDARD COLORS			UPGRADE COLORS	
							
RAW STEEL (not coated)	MATTE BLACK TEXTURE	BRONZE TEXTURE	BLACK	SILVER METALLIC	ARCH BRONZE	RUSTIC BROWN	JACOB'S GOLD
Color code "0"	Color code "MB"	Color code "BZ"	Color code "6"	Color code "1"	Color code "8"	Color code "4"	Color code "G"

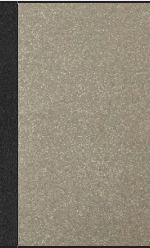
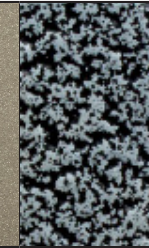
DESIGNER COLORS

								
PC CHROME	REGAL RED	ROCKET WHITE	BLUE RIBBON	FLINT GRAY TEXTURE	DARK GRAY TEXTURE	WHITE BRONZE TEXTURE	SILVER VEIN	COPPER VEIN

Use color code "D" and write the name of the designer color on the order form.

PLEASE NOTE:

- Due to variations in printers and display screens, all color representations above are approximate. Color sample cards are available. Ask your Goldberg Brothers sales representative for details.
- Raw steel does not have a protective coating. Rusting will occur.
- PC Chrome is a powder coat finish with a glossy, chrome-like appearance. It is not chrome plating.
- Steel components used with Matte Black Texture and Bronze Texture may have minor surface blemishes acquired during the manufacturing process. These superficial variations will be hidden by the powder coating and do not affect product performance.



GOLDBERG BROTHERS, INC.

- Award-winning barn door hardware
- House and apartment number signs
- Movie-themed home decor products
- Movie theater projection ports and film reels
- Secure package delivery systems
- Custom metal fabrication

10488 W. Centennial Rd., Suite 100

Littleton, CO 80127 USA

Phone (303) 321-1099 • Fax (303) 388-0749

goldbergbrothers.com