



GOLDBERG BROTHERS

BARN DOOR HARDWARE

2023 EDITION

BARNFOLD® SERIES CATALOG



BARNFOLD® • BARNFOLD® HD





GOLDBERG BROTHERS

BARN DOOR HARDWARE

BARNFOLD® SERIES PRODUCTS CATALOG

TABLE OF CONTENTS

BARNFOLD® Medium-Duty			BARNFOLD® HD Heavy-		
Hardware Sets Medium-Duty		2	Duty Hardware Sets		5
Roller Hangers Medium-Duty		3	Heavy-Duty Roller Hangers		7
Tracks Medium-Duty		3	Heavy-Duty Tracks Heavy-		7
Accessories		3	Duty Accessories		8
			Pull Handles and Flush Pulls	9	
			Configuration Diagrams	10	
			Warranty	12	
			Color samples	inside back cover	

Visit GOLDBERGBROTHERS.COM for additional information and full installation instructions for most products.

Put your barn doors on the right track with the quality and convenience of Goldberg Brothers barn door hardware. Our award-winning products help make efficient use of any indoor living or working space. Our rustic, yet elegant, industrial design provides a bold focal point to any decor.

We designed our medium-duty Barnfold® hardware to work with most medium-weight and light-weight interior door panels in a 2- or 4-panel bifolding configuration. It can replace flimsy bifold door hardware on closets, pantries, and laundry nooks. All medium-duty hardware sets are factory equipped with DuPont™ Delrin® silent rollers.

For larger and heavier doors, we offer heavy-duty Barnfold® HD hardware, made with steel rollers and 2-inch wide hangers and track. Barnfold® HD hardware can be used almost anywhere a conventional interior door can go, and in places where a traditional barn door and track will not fit.

Both versions of Barnfold® hardware are available in 16 powder coat colors. Major steel components are made with up to 90% recycled materials. Barnfold® hardware is protected against manufacturing defects by a limited lifetime warranty.

Goldberg Brothers products have been proudly made in USA since 1897. Our commitment to quality, craftsmanship and value is built into everything we do.

BARNFOLD® SERIES: MEDIUM-DUTY HARDWARE SETS

Barnfold® J-Strap 2-Door Hardware Set

total door weight limit 125 lb, door panel size limit 24"×84" each

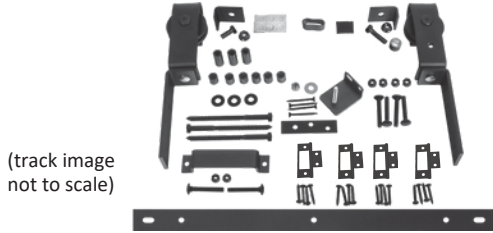

(track image not to scale)

Set for 1¼" to 1½" thick doors includes:

- one pair of reversible J-strap roller hangers
- one 4" pull handle
- four hinges
- one bottom pivot assembly
- all necessary installation hardware

with 24" track (for 1'0" doors)	6007M2D24-*
with 28" track (for 1'2" doors)	6007M2D28-*
with 30" track (for 1'3" doors)	6007M2D30-*
with 32" track (for 1'4" doors)	6007M2D32-*
with 36" track (for 1'6" doors)	6007M2D36-*
with 40" track (for 1'8" doors)	6007M2D40-*
with 42" track (for 1'9" doors)	6007M2D42-*
with 48" track (for 2'0" doors)	6007M2D48-*
without track	6007M2H-*

Barnfold® J-Strap 4-Door Hardware Set

total door weight limit 250 lb, door panel size limit 24"×84" each

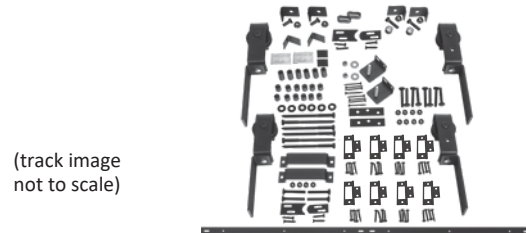

(track image not to scale)

Set for 1¼" to 1½" thick doors includes:

- two pairs of reversible J-strap roller hangers
- two 4" pull handles
- eight hinges
- two bottom pivot assemblies
- all necessary installation hardware

with 48" (for 1'0" doors)	6007M4D48-*
with 56" (for 1'2" doors)	6007M4D56-*
with 60" (for 1'3" doors)	6007M4D60-*
with 64" (for 1'4" doors)	6007M4D64-*
with 72" (for 1'6" doors)	6007M4D72-*
with 80" (for 1'8" doors)	6007M4D80-*
with 84" (for 1'9" doors)	6007M4D84-*
with 96" (for 2'0" doors)	6007M4D96-*
without track	6007M4H-*

Barnfold® J-Top Mount 2-Door Hardware Set

total door weight limit 125 lb, door panel size limit 24"×84" each

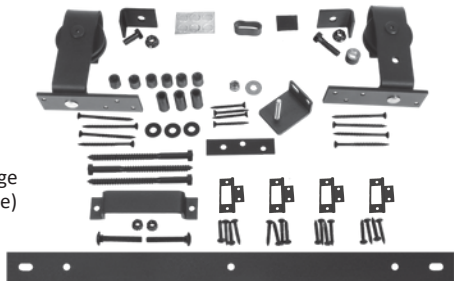

(track image not to scale)

Set for 1¼" to 1½" thick doors includes:

- one pair of reversible J top mount roller hangers
- one 4" pull handle
- four hinges
- one bottom pivot assembly
- all necessary installation hardware

with 24" track (for 1'0" doors)	6007M2DTM24
with 28" track (for 1'2" doors)	_*
with 30" track (for 1'3" doors)	6007M2DTM28
with 32" track (for 1'4" doors)	_*
with 36" track (for 1'6" doors)	6007M2DTM30
with 40" track (for 1'8" doors)	_*
with 42" track (for 1'9" doors)	6007M2DTM32
with 48" track (for 2'0" doors)	_*
without track	6007M2DTM36

_*
6007M2DTM40
_*
6007M2DTM42
_*

Barnfold® J-Top Mount 4-Door Hardware Set

total door weight limit 250 lb, door panel size limit 24"×84" each

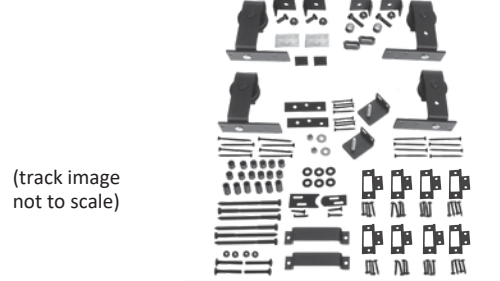

(track image not to scale)

Set for 1¼" to 1½" thick doors includes:

- two pairs of reversible J top mount roller hangers
- two 4" pull handles
- eight hinges
- two bottom pivot assemblies
- all necessary installation hardware

with 48" (for 1'0" doors)	6007M4DTM48
with 56" (for 1'2" doors)	_*
with 60" (for 1'3" doors)	6007M4DTM56
with 64" (for 1'4" doors)	_*
with 72" (for 1'6" doors)	6007M4DTM60
with 80" (for 1'8" doors)	_*
with 84" (for 1'9" doors)	6007M4DTM64
with 96" (for 2'0" doors)	_*
without track	6007M4DTM72

_*
6007M4DTM80
_*
6007M4DTM84
_*

BARNFOLD® SERIES: MEDIUM-DUTY ROLLER HANGERS, TRACKS, ACCESSORIES

Barnfold® J-Strap Hanger (1 each, with bolts and nuts)



11/2"×10"×11/2"

Fixed hanger (reversible for left or right side) 6007MRFX-*

Barnfold® J-Top Mount Hanger (1 each, with screws)



31/2"×41/2"×11/2"

Fixed hanger (reversible for left or right side) 6007MRFXTM-*

Barnfold® J-Strap Hanger (1 each, with bolts and nuts)



11/2"×10"×11/2"

Loose hanger (reversible for left or right side) 6007MRLS-*

Barnfold® J-Top Mount Hanger (1 each, with screws)



31/2"×41/2"×11/2"

Loose hanger (reversible for left or right side) 6007MRLSTM-*

Barnfold® 2-Door Track



11/2"×3/16"

24" track (for 1'0" doors)	6007MT224-*
28" track (for 1'2" doors)	6007MT228-*
30" track (for 1'3" doors)	6007MT230-*
32" track (for 1'4" doors)	6007MT232-*
36" track (for 1'6" doors)	6007MT236-*
40" track (for 1'8" doors)	6007MT240-*
42" track (for 1'9" doors)	6007MT242-*
48" track (for 2'0" doors)	6007MT248-*

Barnfold® 4-Door Track



11/2"×3/16"

48" track (for 1'0" doors)	6007MT448-*
56" track (for 1'2" doors)	6007MT456-*
60" track (for 1'3" doors)	6007MT460-*
64" track (for 1'4" doors)	6007MT464-*
72" track (for 1'6" doors)	6007MT472-*
80" track (for 1'8" doors)	6007MT480-*
84" track (for 1'9" doors)	6007MT484-*
96" track (for 2'0" doors)	6007MT496-*

Barnfold® 4-Door Alignment Plates (set, with screws)



13/4"×3/4" and 2"×1"

6007BFA-*

Barnfold® 2-door Adapter Kit for 1½" to 1¾" doors



6007M4K2-*

Replace the * in the product's SKU with the code for the desired color. See inside back cover for color samples and codes.

BARNFOLD® SERIES: MEDIUM-DUTY ACCESSORIES

Barnfold® 4-door Adapter Kit for 1½" to 1¾" doors



6007M4K4-*

Barnfold® Bottom Pivot Kit (1 set, with screws)

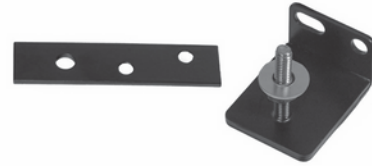

for 1¼" and 1⅜" thick doors

6007MP-*

for 1½" - 1¾" thick doors

6007MP4-*

Barnfold® 2-door Extension Kit (3 bolts, 3 spacers)



½" extension

6007M2E-*

7/8" extension

6007M2EX-*

Barnfold® 4-door Extension Kit (6 bolts, 6 spacers)



½" extension

6007M4E-*

7/8" extension

6007M4EX-*

Barnfold® Adjustable Track Stop (1 each)



15/8"×13/8"×3/4"

6007MSA-*

Barnfold® Hinge (1 each, with screws)



15/8"×21/2"

6007MH-*

4" Pull Handle (1 each, with bolts and nuts)



1"×4" CL bolts×3/4"

for 1¼" and 1⅜" thick doors

6007PH304-*

for 1½" - 1¾" thick doors

6007PH404-*

3" Flush Pull (1 each, with faceplate, dustbox and screws)



See page 15 for dimensions

6003FP03-*

Replace the * in the product's SKU with the code for the desired color. See inside back cover for color samples and codes.

BARNFOLD® SERIES: HEAVY-DUTY HARDWARE AND TRACK SETS

Barnfold® HD J-Strap 2-Door Hardware Set

total door weight limit 400 lb, door panel size limit 48"×108" each

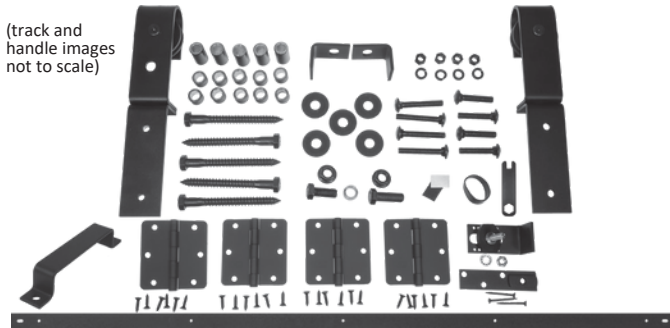

Set includes:

- one 2-door track
- one pair of reversible J-strap roller hangers
- four hinges
- one bottom pivot assembly
- one 7" pull handle
- all necessary installation hardware

with 24" track (for 1'0" doors)	for 1¼" to 13/4" thick doors	6007H2D24-*
	for 2¼" thick doors	6007H52D24-*
with 28" track (for 1'2" doors)	for 1¼" to 13/4" thick doors	6007H2D28-*
	for 2¼" thick doors	6007H52D28-*
with 30" track (for 1'3" doors)	for 1¼" to 13/4" thick doors	6007H2D30-*
	for 2¼" thick doors	6007H52D30-*
with 32" track (for 1'4" doors)	for 1¼" to 13/4" thick doors	6007H2D32-*
	for 2¼" thick doors	6007H52D32-*
with 36" track (for 1'6" doors)	for 1¼" to 13/4" thick doors	6007H2D36-*
	for 2¼" thick doors	6007H52D36-*
with 40" track (for 1'8" doors)	for 1¼" to 13/4" thick doors	6007H2D42-*
	for 2¼" thick doors	6007H52D42-*
with 42" track (for 1'9" doors)	for 1¼" to 13/4" thick doors	6007H2D48-*
	for 2¼" thick doors	6007H52D48-*
with 48" track (for 2'0" doors)	for 1¼" to 13/4" thick doors	6007H2D56-*
	for 2¼" thick doors	6007H52D56-*
with 56" track (for 2'4" doors)	for 1¼" to 13/4" thick doors	6007H2D60-*
	for 2¼" thick doors	6007H52D60-*
with 60" track (for 2'6" doors)	for 1¼" to 13/4" thick doors	6007H2D64-*
	for 2¼" thick doors	6007H52D64-*
with 64" track (for 2'8" doors)	for 1¼" to 13/4" thick doors	6007H2D72-*
	for 2¼" thick doors	6007H52D72-*
with 72" track (for 3'0" doors)	for 1¼" to 13/4" thick doors	6007H2D84-*
	for 2¼" thick doors	6007H52D84-*
with 84" track (for 3'6" doors)	for 1¼" to 13/4" thick doors	6007H2D96-*
	for 2¼" thick doors	6007H52D96-*
with 96" track (for 4'0" doors)	for 1¼" to 13/4" thick doors	6007H2DH-*
	for 2¼" thick doors	6007H52DH-*

without track

Barnfold® HD J-Strap 4-Door Hardware Set

total door weight limit 800 lb, door panel size limit 48"×108" each

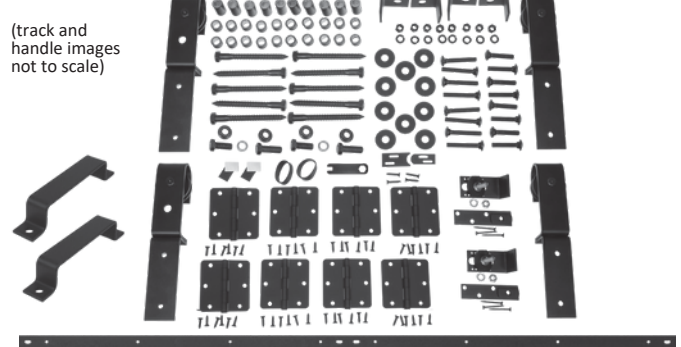

Set includes:

- one or two tracks for 4-door installation (and one track connecting plate if needed)
- two pairs of reversible J-strap roller hangers
- eight hinges
- two bottom pivot assemblies
- two 7" pull handles
- one set of 4-door alignment plates
- all necessary installation hardware

with 48" track (for 1'0" doors)	for 1¼" to 13/4" thick doors	6007H4D48-*
	for 2¼" thick doors	6007H54D48-*
with 56" track (for 1'2" doors)	for 1¼" to 13/4" thick doors	6007H4D56-*
	for 2¼" thick doors	6007H54D56-*
with 60" track (for 1'3" doors)	for 1¼" to 13/4" thick doors	6007H4D60-*
	for 2¼" thick doors	6007H54D60-*
with 64" track (for 1'4" doors)	for 1¼" to 13/4" thick doors	6007H4D64-*
	for 2¼" thick doors	6007H54D64-*
with 72" track (for 1'6" doors)	for 1¼" to 13/4" thick doors	6007H4D72-*
	for 2¼" thick doors	6007H54D72-*
with 80" track (for 1'8" doors)	for 1¼" to 13/4" thick doors	6007H4D80-*
	for 2¼" thick doors	6007H54D80-*
with 84" track (for 1'9" doors)	for 1¼" to 13/4" thick doors	6007H4D84-*
	for 2¼" thick doors	6007H54D84-*
with 84" track (for 1'9" doors)	for 1¼" to 13/4" thick doors	6007H4D96-*
	for 2¼" thick doors	6007H54D96-*
with 96" track (for 2'0" doors)	for 1¼" to 13/4" thick doors	6007H4D96-*
	for 2¼" thick doors	6007H54D96-*
with two 56" tracks, 112" total (for 2'4" doors)	for 1¼" to 13/4" thick doors	6007H4D56-*
	for 2¼" thick doors	6007H54D56-*
with two 60" tracks, 120" total (for 2'6" doors)	for 1¼" to 13/4" thick doors	6007H4D60-*
	for 2¼" thick doors	6007H54D60-*
with two 64" tracks, 128" total (for 2'8" doors)	for 1¼" to 13/4" thick doors	6007H4D72-*
	for 2¼" thick doors	6007H54D72-*
with two 72" tracks, 144" total (for 3'0" doors)	for 1¼" to 13/4" thick doors	6007H4D84-*
	for 2¼" thick doors	6007H54D84-*
with two 84" tracks, 168" total (for 3'6" doors)	for 1¼" to 13/4" thick doors	6007H4D96-*
	for 2¼" thick doors	6007H54D96-*
with two 96" tracks, 192" total (for 4'0" doors)	for 1¼" to 13/4" thick doors	6007H4DH-*
	for 2¼" thick doors	6007H54DH-*

without track

Replace the * in the product's SKU with the code for the desired color. See inside back cover for color samples and codes.

BARNFOLD® SERIES: HEAVY-DUTY HARDWARE AND TRACK SETS

Barnfold® HD J Top Mount 2-Door Hardware Set

total door weight limit 400 lb, door panel size limit 48"x108" each

(track and handle images not to scale)

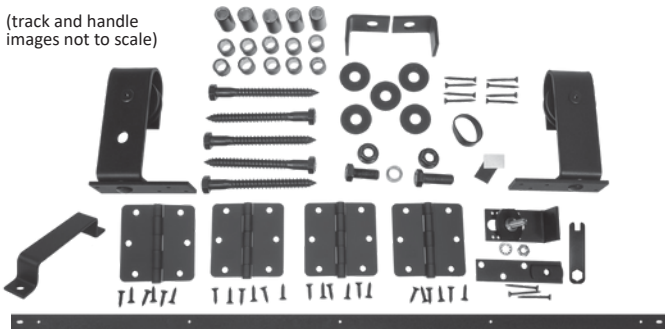

Set includes:

- one 2-door track
- one pair of reversible J top mount roller hangers
- four hinges
- bottom pivot assembly
- one 7" pull handle
- all necessary installation hardware

with 24" track (for 1'0" doors)	for most 1¼"+ thick doors	6007H02D24-*
with 28" track (for 1'2" doors)	for most 1¼"+ thick doors	6007H02D28-*
with 30" track (for 1'3" doors)	for most 1¼"+ thick doors	6007H02D28-*
with 32" track (for 1'4" doors)	for most 1¼"+ thick doors	6007H02D32-*
with 36" track (for 1'6" doors)	for most 1¼"+ thick doors	6007H02D36-*
with 40" track (for 1'8" doors)	for most 1¼"+ thick doors	6007H02D40-*
with 42" track (for 1'9" doors)	for most 1¼"+ thick doors	6007H02D42-*
with 48" track (for 2'0" doors)	for most 1¼"+ thick doors	6007H02D48-*
with 56" track (for 2'4" doors)	for most 1¼"+ thick doors	6007H02D56-*
with 60" track (for 2'6" doors)	for most 1¼"+ thick doors	6007H02D64-*
with 64" track (for 2'8" doors)	for most 1¼"+ thick doors	6007H02D72-*
with 72" track (for 3'0" doors)	for most 1¼"+ thick doors	6007H02D84-*
with 84" track (for 3'6" doors)	for most 1¼"+ thick doors	6007H02D96-*
with 96" track (for 4'0" doors)	for most 1¼"+ thick doors	6007H02DH-*
without track		

Barnfold® HD J Top Mount 4-Door Hardware Set

total door weight limit 800 lb, door panel size limit 48"x108" each

(track and handle images not to scale)

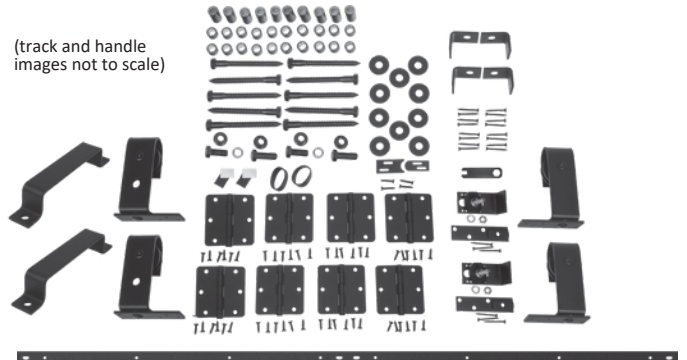

Set includes:

- one or two tracks for 4-door installation (and one track connecting plate if needed)
- two pairs of reversible J top mount roller hangers
- eight hinges
- two bottom pivot assemblies
- one set of 4-door alignment plates
- two 7" pull handles
- all necessary installation hardware

with 48" track (for 1'0" doors)	for most 1¼"+ thick doors	6007H04D48-*
with 56" track (for 1'2" doors)	for most 1¼"+ thick doors	6007H04D56-*
with 60" track (for 1'3" doors)	for most 1¼"+ thick doors	6007H04D60-*
with 64" track (for 1'4" doors)	for most 1¼"+ thick doors	6007H04D64-*
with 72" track (for 1'6" doors)	for most 1¼"+ thick doors	6007H04D72-*
with 80" track (for 1'8" doors)	for most 1¼"+ thick doors	6007H04D80-*
with 84" track (for 1'9" doors)	for most 1¼"+ thick doors	6007H04D84-*
with 96" track (for 2'0" doors)	for most 1¼"+ thick doors	6007H04D96-*
with two 56" tracks, 112" total (for 2'4" doors)	for most 1¼"+ thick doors	6007H04D112-*
with two 60" tracks, 120" total (for 2'6" doors)	for most 1¼"+ thick doors	6007H04D120-*
with two 64" tracks, 128" total (for 2'8" doors)	for most 1¼"+ thick doors	6007H04D128-*
with two 72" tracks, 144" total (for 3'0" doors)	for most 1¼"+ thick doors	6007H04D144-*
with two 84" tracks, 168" total (for 3'6" doors)	for most 1¼"+ thick doors	6007H04D168-*
with two 96" tracks, 192" total (for 4'0" doors)	for most 1¼"+ thick doors	6007H04D192-*
without track		

Replace the * in the product's SKU with the code for the desired color. See inside back cover for color samples and codes.

BARNFOLD® SERIES: HEAVY-DUTY ROLLER HANGERS, TRACKS

Barnfold® HD J-Strap Hanger - Fixed (each, with bolts and nuts)

2"×10"×11/2"



Reversible for left or right side	for 1¼" to 13/4" thick doors	6007HRF-*
Reversible for left or right side	for 2¼" thick doors	6007H5RF-*

Barnfold® HD J-Strap Hanger - Loose (each, with bolts and nuts)

2"×10"×11/2"



Reversible for left or right side	for 1¼" to 13/4" thick doors	6007HRL-*
Reversible for left or right side	for 2¼" thick doors	6007H5RL-*

Barnfold® HD J-Top Mount Hanger - Fixed (each, with screws)

31/2"×41/2"×2"



Reversible for left or right side	for 1¼" to 13/4" thick doors	6007HRFTM-*
-----------------------------------	------------------------------	-------------

Barnfold® HD J-Top Mount Hanger - Loose (each, with screws)

31/2"×41/2"×2"



Reversible for left or right side	for 1¼" to 13/4" thick doors	6007HRLTM-*
-----------------------------------	------------------------------	-------------

Barnfold® HD 2-Door Track



2"×3/16"

24" track (for 1'0" doors)	6007HT224-*
28" track (for 1'2" doors)	6007HT228-*
30" track (for 1'3" doors)	6007HT230-*
32" track (for 1'4" doors)	6007HT232-*
36" track (for 1'6" doors)	6007HT236-*
40" track (for 1'8" doors)	6007HT240-*
42" track (for 1'9" doors)	6007HT242-*
48" track (for 2'0" doors)	6007HT248-*
56" track (for 2'0" doors)	6007HT256-*
60" track (for 2'0" doors)	6007HT260-*
64" track (for 2'0" doors)	6007HT264-*
72" track (for 2'0" doors)	6007HT272-*
84" track (for 2'0" doors)	6007HT284-*
96" track (for 2'0" doors)	6007HT296*

Barnfold® HD 4-Door Track



2"×3/16"

48" track (for 1'0" doors)	6007HT448-*
56" track (for 1'2" doors)	6007HT456-*
60" track (for 1'3" doors)	6007HT460-*
64" track (for 1'4" doors)	6007HT464-*
72" track (for 1'6" doors)	6007HT472-*
80" track (for 1'8" doors)	6007HT480-*
84" track (for 1'9" doors)	6007HT484-*
96" track (for 2'0" doors)	6007HT496-*

BARNFOLD® SERIES: HEAVY-DUTY ACCESSORIES

Barnfold® HD Wall Mounting Kit (sets of bolts, spacers, washers)



for 1 1/4" to 1 3/4" thick doors	6007HM-*
for 2 1/4" thick doors	60075HM-*

Barnfold® HD Track Stop (1 each)



1 13/16" x 1 1/2" x 3/4"

reversible and adjustable for left or right side	6007HS-*
--	----------

Barnfold® HD Hinge (1 each, with screws)



3 1/2" x 3 1/2"

6007HH-*

Barnfold® HD Bottom Pivot Kit (set with installation hardware)

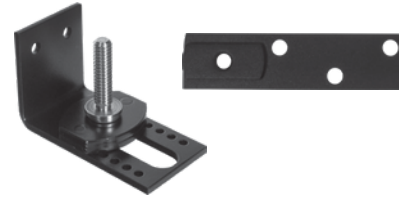

for 1 1/4" to 2 1/4" thick doors

6007HP-*

Barnfold® HD Track Connecting Plate (1 each)



6007HC-*

4-Door Alignment Plates (1 set, with screws)



1 3/4" x 3/4" and 2" x 1"

for use with original Barnfold® or Barnfold® HD 6007BFA-*

BARNFOLD® SERIES: HEAVY-DUTY PULL HANDLES, FLUSH PULLS, EDGE PULLS

7" Pull Handle Set (2 each, with bolts, washers and nuts)

1½"×7" CL bolts×1¼"



Universal for 1³/₈", 1³/₄", 2¹/₄" or thick door 6007PPH207-*

6" Flush Pull Set (2 each, with face plate, dustbox and screws)

cover plate 2½"×6"
dustbox 2"×5"×½"



6007PFP206-*

11" Pull Handle Set (1 each, with bolts, washers and nuts)

1½"×11" CL bolts×1¼"



Universal for 1³/₈", 1³/₄", 2¹/₄" or thick door 6007PPH211-*

12" Flush Pull Set (2 each, with face plate, dustbox and screws)

cover plate 2½"×12"
dustbox 2"×11"×½"



6007PFP212-*

6" Edge Pull Set (2 each, with screws)

15/8"×6"×1"
fits 1³/₈" to 2¹/₄"
thick doors



6007PEP206-*

Router Templates (set of 3, clear plastic)



flush pulls and privacy latch templates

6001TMP-2

10" Edge Pull Set (2 each, with screws)

15/8"×10"×1"
fits 1³/₈" to 2¹/₄"
thick doors



6007PEP210-*

See our Standard Series and General Hardware catalogs for additional sizes and styles, and for handles sold individually.

2 DOORS, LESS THAN CLEAR OPENING

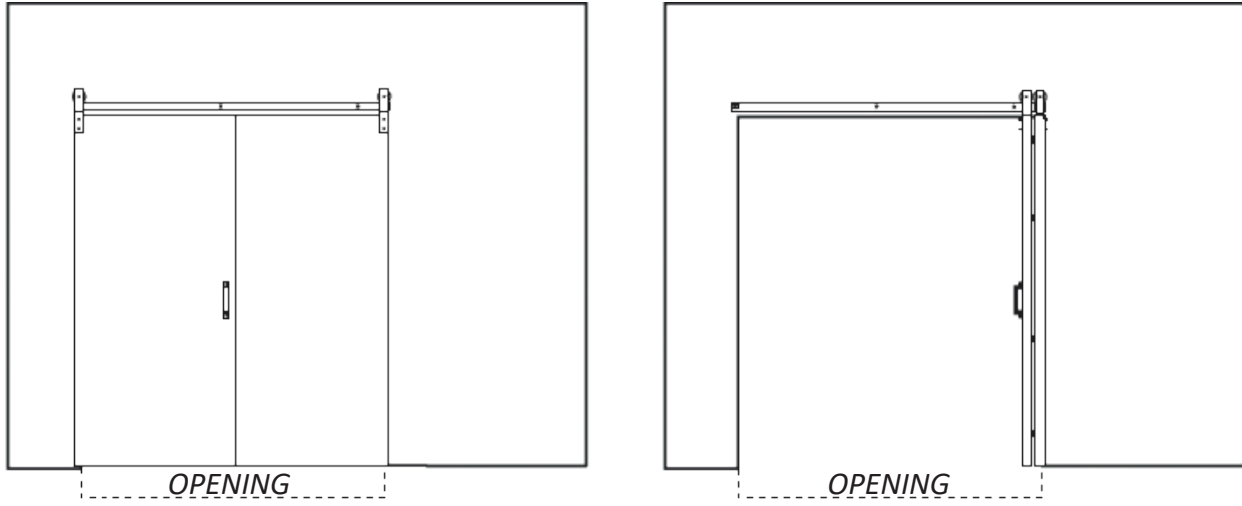

The stacked doors will hang over into the opening up to 4" in the fully opened position, with a minimum wall overlap of 1" on each side when fully closed.

2 DOORS, CLEAR OPENING

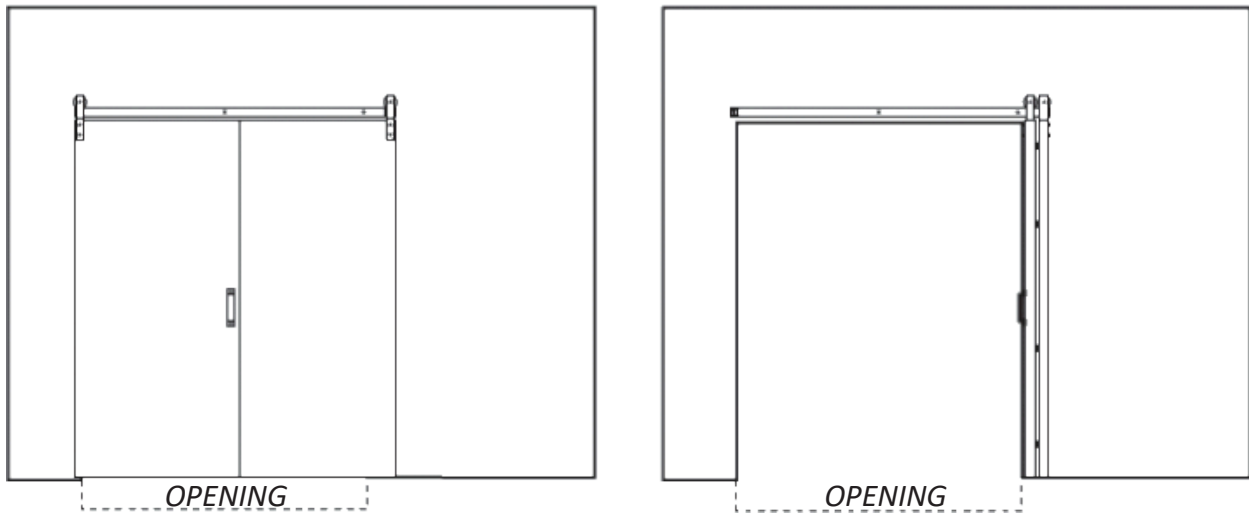

The stacked doors will not hang over into the opening in the fully opened position, with a minimum wall overlap of 5" on the stacking side and 1" on the closing side.

The hardware can be configured to allow the doors to open either to the left or to the right. For more detailed information, visit goldbergbrothers.com to view Barnfold® installation instructions and sizing reference charts.

4 DOORS, LESS THAN CLEAR OPENING

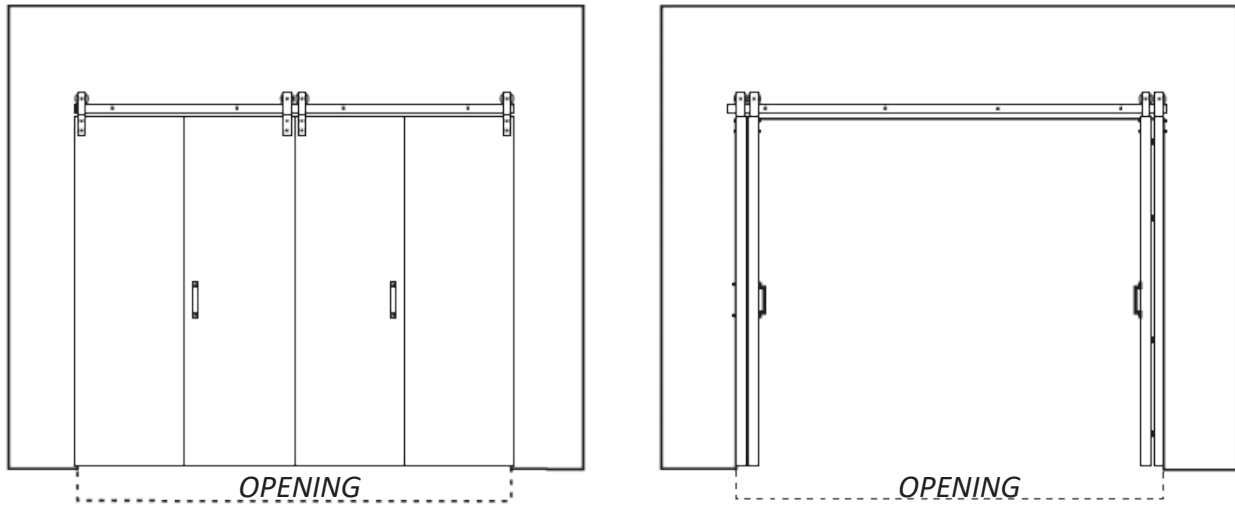

The stacked doors will hang over into the opening up to 4" in the fully opened position, with a minimum wall overlap of 1" on each side when fully closed.

4 DOORS, CLEAR OPENING

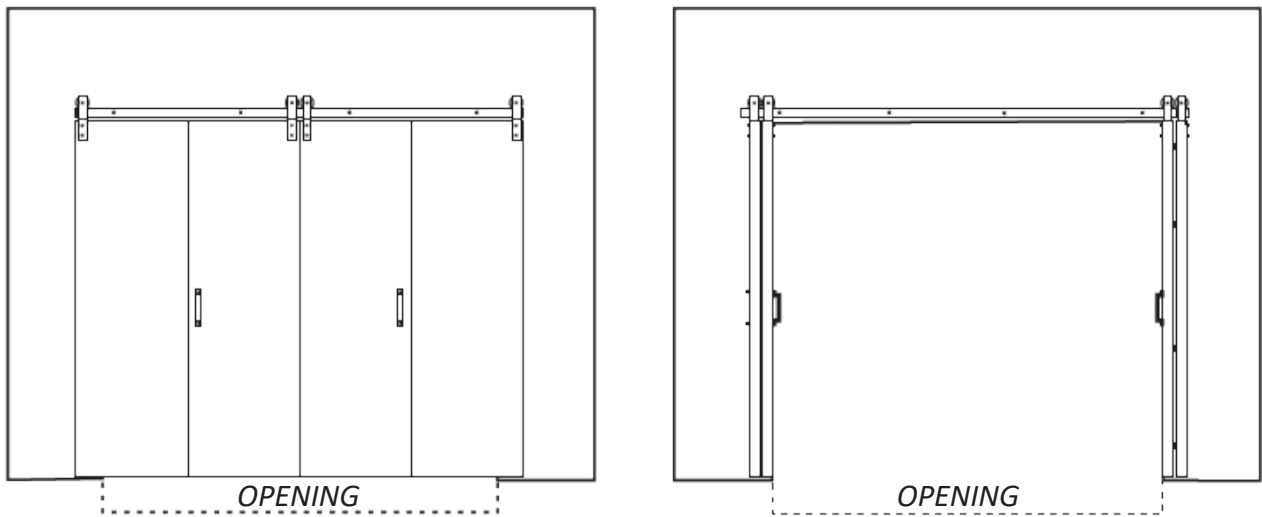

The stacked doors will not hang over into the opening in the fully opened position, with a minimum wall overlap of 5" on each side.

For more detailed information, visit goldbergbrothers.com to view Barnfold® installation instructions and sizing reference charts.

WARRANTY

LIMITED LIFETIME MANUFACTURER'S WARRANTY

Goldberg Brothers warrants the functionality of its barn door hardware sets and tracks with a limited lifetime manufacturer's warranty for defective parts under normal installation and use. Warranty is subject to repair or replacement of defective components at manufacturer's discretion and does not include installation costs.

This warranty does not apply to the cosmetic condition of any products or components. Goldberg Brothers barn door hardware is sold as a rustic finished hardware and may develop scratches or other signs of wear during manufacturing or normal installation and use. Further, Goldberg Brothers does not warrant against any cosmetic imperfections in the steel parts that may be seen through the finish.

Certain accessories including but not limited to felt strips, rubber bumper bands, pair linking cords, and Soft Stop motion buffer mechanisms have finite expected lifetimes due to wear and loss of tension or resilience during normal use over an extended period. Except for manufacturing defects that become apparent within 1 year of purchase, these accessories are not covered under this limited lifetime warranty. Replacement accessories may be purchased as needed from Goldberg Brothers retailers.

Except for stainless steel components, Goldberg Brothers barn door hardware products are not warranted against rust. Some rusting is possible on any raw steel or powder coated steel hardware installed outdoors or anywhere else that it may be exposed to high humidity, rain, snow, or running water.

This warranty does not include loss or defects caused by elements outside the control of Goldberg Brothers, Inc., such as natural disasters, weather, fire, water leakage, abuse, improper installation, or anything else deemed out of the control of Goldberg Brothers, Inc.





GOLDBERG BROTHERS
BARN DOOR HARDWARE



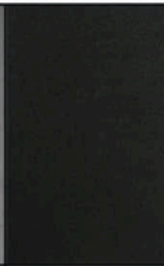
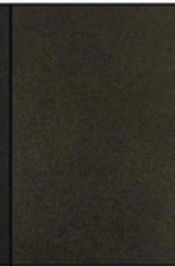



BARNFOLD® SERIES HARDWARE COLORS

Products with SKUs that end with a dash and asterisk -* are available in multiple colors.
 Replace the asterisk * with the desired color code.

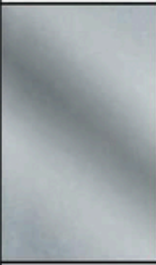
ECONOMY COLORS		
		
RAW STEEL (not coated)	MATTE BLACK TEXTURE	BRONZE TEXTURE
Color code "0"	Color code "MB"	Color code "BZ"

STANDARD COLORS		
		
BLACK	SILVER METALLIC	ARCH BRONZE
Color code "6"	Color code "1"	Color code "8"

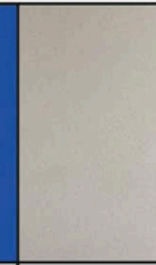
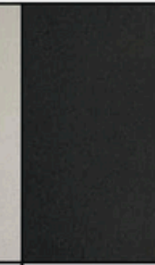
UPGRADE COLORS	
	
RUSTIC BROWN	JACOB'S GOLD
Color code "4"	Color code "G"

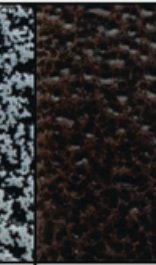
DESIGNER COLORS								
								
PC CHROME (not chrome plating)	REGAL RED	ROCKET WHITE	BLUE RIBBON	FLINT GRAY TEXTURE	DARK GRAY TEXTURE	WHITE BRONZE TEXTURE	SILVER VEIN	COPPER VEIN

Use color code "D" and write the name of the designer color on the order form.

PLEASE NOTE:

- Due to variations in printers and display screens, all color representations above are approximate. Color sample cards are available. Ask your Goldberg Brothers sales representative for details.
- Raw steel does not have a protective coating. Rusting will occur.
- PC Chrome is a powder coat finish with a glossy, chrome-like appearance. It is not chrome plating.
- Steel components used with Matte Black Texture and Bronze Texture may have minor surface blemishes acquired during the manufacturing process. These superficial variations will be hidden by the powder coating and do not affect product performance.



GOLDBERG BROTHERS, INC.

- **Award-winning barn door hardware**
- **House and apartment number signs**
- **Movie-themed home decor products**
- **Movie theater projection ports and film reels**
- **Secure package delivery systems**
- **Custom metal fabrication**

10488 W. Centennial Rd., Suite 100

Littleton, CO 80127 USA

Phone (303) 321-1099 • Fax (303) 388-0749

goldbergbrothers.com