

Goldberg Brothers

Shutter Series - Track & Hardware

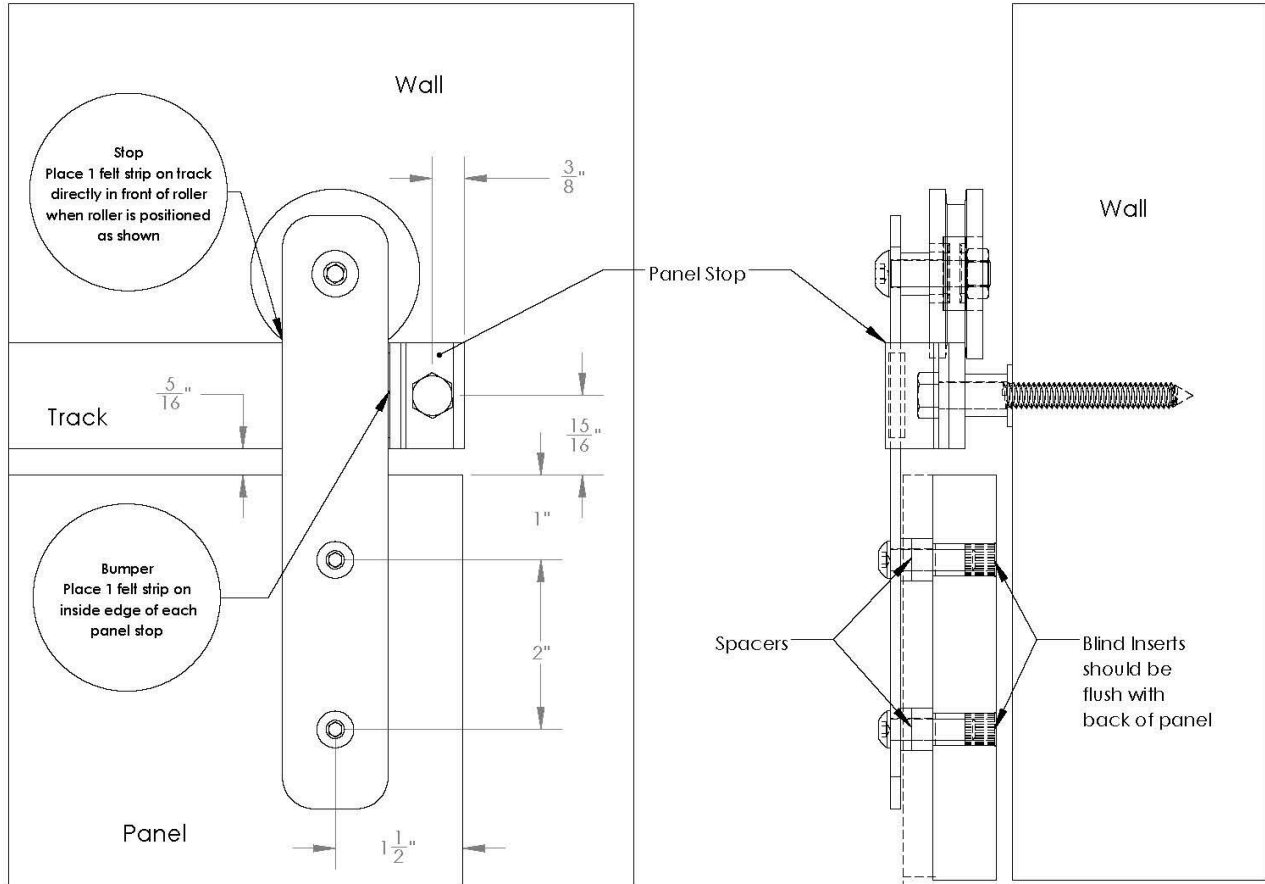

NOTE: Spacers should be added as follows to accommodate various panel thicknesses

Panel Thickness	Spacers
3/4"	1/8" + 1/4"
7/8"	1/4"
1"	1/8"
1-1/8"	None

3/16"
Varying Panel Thicknesses

Wall Mounted Panel Guide

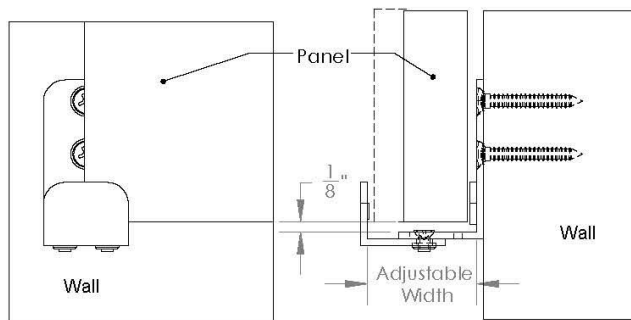

Replacement Part Kits

Hanger, Roller, & Hardware
1 ea.
Part #: 6003R-X*

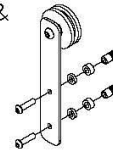

Panel Guide
1 ea.
Part #: 60038U-X*

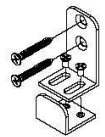

Track Mounting Hardware
1 pk. of 4
Part #: 6003M-X*

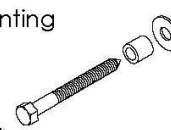

Panel Stop
1 ea.
Part #: 60038S-X*



Optional Part Kits

Track Connecting Plate
1 ea.
Part #: 6003C-X*



Extension Kit
1 pk. of 4
Part #: 6003E-X*

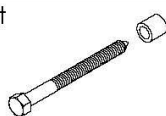

Bypass Bracket
1 pk. of 4
Part #: 6003BP-X*

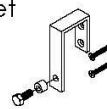

Panel Guide w/ Extensions
1 ea.
Part #: 60038UX-X*

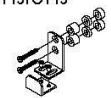

*X indicates that the related part is available in all colors

Goldberg Brothers Shutter Series

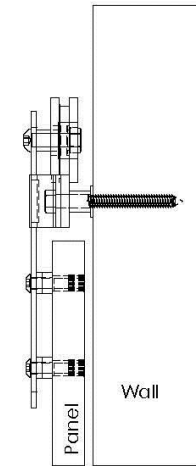

Std Hardware Pack installed with no casing, or other trim

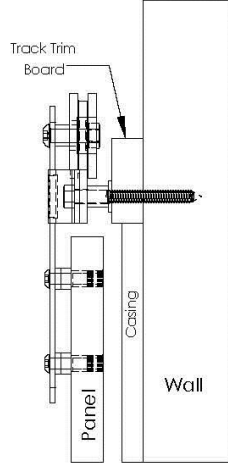

Std Hardware Pack installed on track trim board that is equal to or thicker than casing or other trim

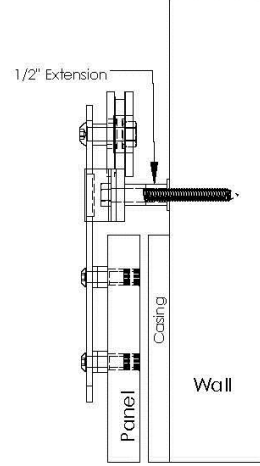

Std Hardware Pack + 1/2" Extension Kit installed where casing or other trim is up to 1/2" thick

Bypass System

Bypass kit includes all standard parts and hardware, minus track

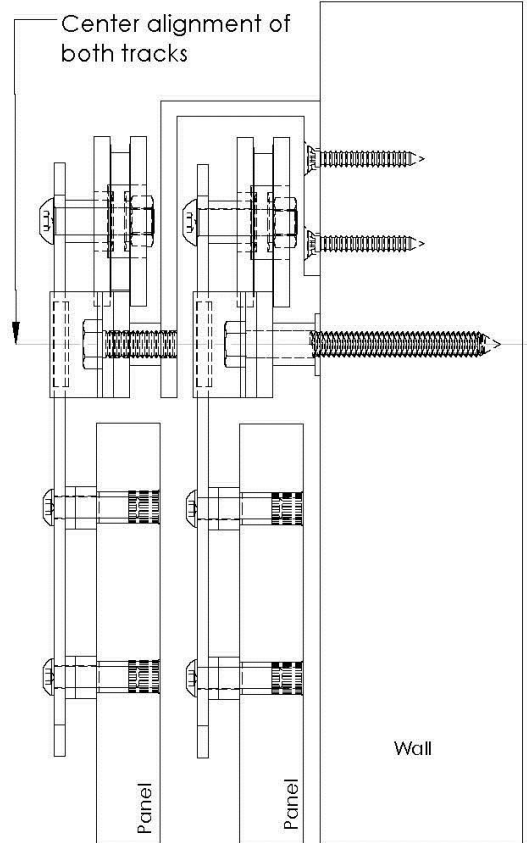
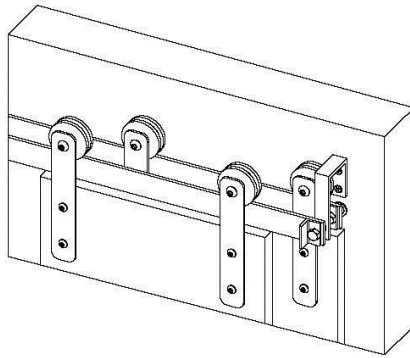

Panel Guide Layout

Panel Thickness	Spacers
3/4"	1/8" + 1/4" + 3/8"
7/8"	1/4" + 3/8"
1"	1/8" + 3/8"
1-1/8"	3/8"

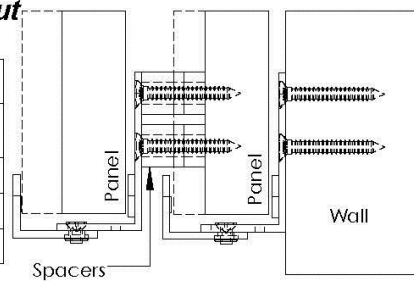

Bypass System Layouts

